

EMERALD COLLECTION

EXTERNAL DIMENSION

THREE ON RING CLIP STYLE DISPLAY

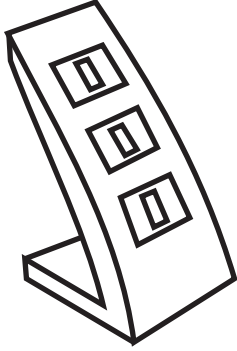

* **EME 001** 75mm wide x 172mm high x 120mm front to back

THREE ON RING SOFT ROLL STYLE DISPLAY

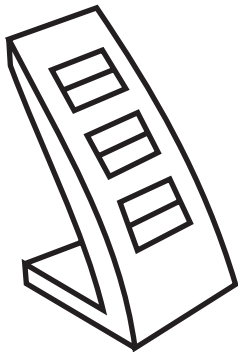

EXTERNAL DIMENSION

* **EME 010** 75mm wide x 172mm high x 120mm front to back

BRACELET WITH ADJUSTABLE ELASTIC LOOP DISPLAY

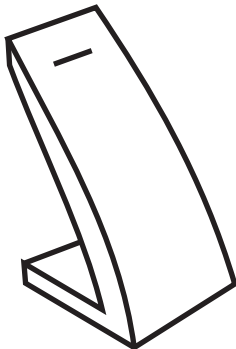

EXTERNAL DIMENSION

* **EME 020** 75mm wide x 172mm high x 120mm front to back

* **EME 021** 40mm wide x 172mm high x 120mm front to back

FOUR PAIRS OF STUD EARRING DISPLAY

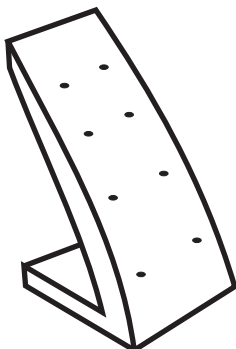

EXTERNAL DIMENSION

* **EME 030** 75mm wide x 172mm high x 120mm front to back

EMERALD COLLECTION

SINGLE RING SOFT ROLL DISPLAY



- * EME 040** 50mm x 50mm x 28mm high
- * EME 041** 50mm x 50mm x 38mm high
- * EME 042** 50mm x 50mm x 48mm high
-

EXTERNAL DIMENSION

SINGLE RING WITH CLIP DISPLAY

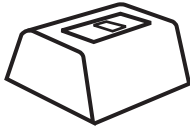

- * EME 050** 50mm x 50mm x 28mm high
- * EME 051** 50mm x 50mm x 38mm high
- * EME 052** 50mm x 50mm x 48mm high
-

EXTERNAL DIMENSION

FOUR ON SINGLE RING SOFT ROLL DISPLAY
TWO RING SOFT ROLL ON EACH FACE FRONT & BACK

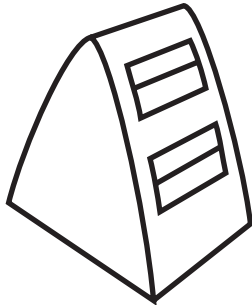

- * EME 060** 46mm wide x 93mm high x 102mm
-

EXTERNAL DIMENSION

FOUR ON SINGLE RING WITH CLIP DISPLAY
TWO RING WITH CLIP ON EACH FACE FRONT & BACK

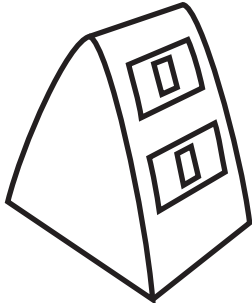

- * EME 070** 46mm wide x 93mm high x 102mm
-

EXTERNAL DIMENSION

NECKLACE DISPLAY WITH BACK POCKET
& ADJUSTABLE STRAPS

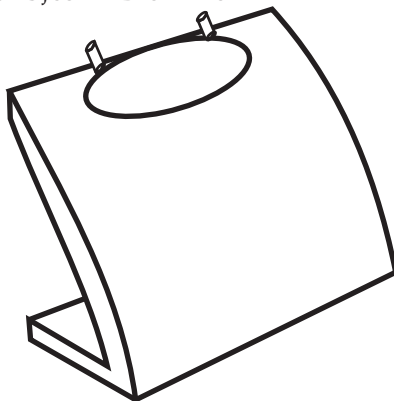

- * EME 080** 190mm wide x 172mm high x 120mm front to back
-

EXTERNAL DIMENSION

EMERALD COLLECTION

DISPLAY UNIT WITH TWO SECTIONS
TO HOLD REMOVABLE INSERT PADS

EXTERNAL DIMENSION

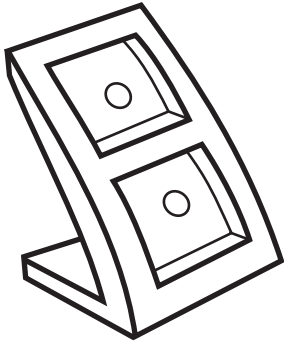

* **EME 090**

115mm wide x 172mm high x 120mm front to back

INNER FLAP STYLE EARRING PAD
TO FIT INTO DISPLAY UNIT EME090

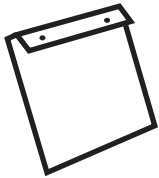

* **EME 091**

74mm x 74mm x flap 13mm

INNER PENDANT STYLE PAD
TO FIT INTO DISPLAY UNIT EME090

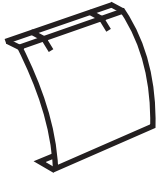

* **EME 092**

74mm x 74mm x 13mm

DISPLAY UNIT WITH ONE SECTION
TO HOLD REMOVABLE INSERT PAD

EXTERNAL DIMENSION

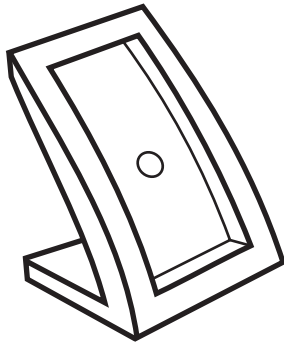

* **EME 110**

115mm wide x 172mm high x 120mm front to back

INNER PENDANT STYLE PAD TO FIT
INTO DISPLAY UNIT EME110

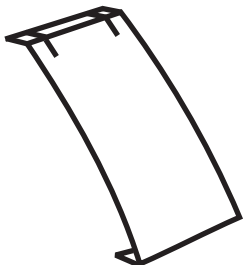

* **EME 111**

75mm wide x 170mm x 20mm

EMERALD COLLECTION

EXTERNAL DIMENSION

DISPLAY UNIT WITH THREE SECTIONS
TO HOLD REMOVABLE INSERT PADS

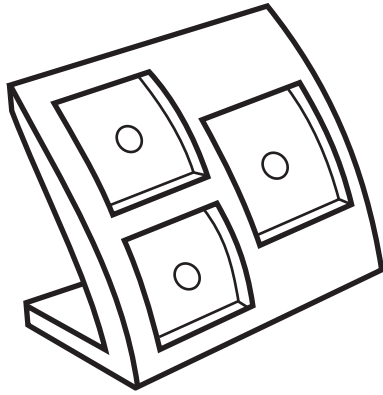

* **EME 120** 190mm wide x 172mm high x 120mm front to back

INNER PENDANT STYLE PAD
TO FIT INTO DISPLAY UNIT EME120

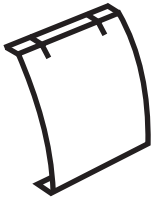

* **EME 121** 70mm x 80mm x 15mm

DROP EARRING STYLE PAD
TO FIT INTO DISPLAY UNIT EME120

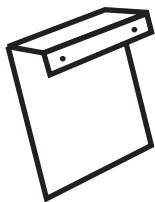

* **EME 122** 70mm x 80mm x flap 40mm

INNER FLAP STYLE EARRING PAD
TO FIT INTO DISPLAY UNIT EME120

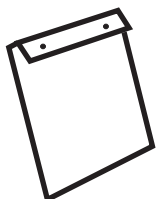

* **EME 123** 70mm x 80mm x flap 15mm

EMERALD COLLECTION

EXTERNAL DIMENSION

BLOCK DISPLAY

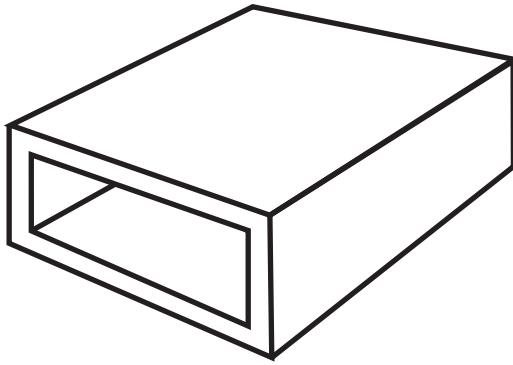

- * **EME 130** 248mm x 212mm x 122mm high
 - * **EME 131** 118mm x 118mm x 118mm high
 - * **EME 132** 80mm x 80mm x 80mm high
-